

CHIMNEY

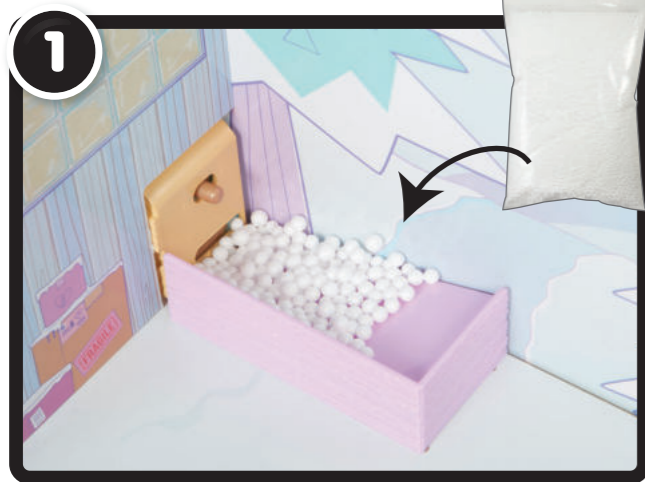

1 Add the snow. DO NOT OVERFILL.



2 Turn the switch to turn on chimney.
Push the snow with the scoop.
NOTE: DO NOT BLOCK THE VENT.

SKATING RINK



1 Fill with water in the shaded areas shown above. Then, place in the freezer. Wait until it is frozen and place over the base. DO NOT OVERFILL INTO THE SKATING RINK TRACK.



2 Place dressed doll on the stand and insert the stand on the skating rink track.

Use ski boots for O.M.G.™ fashion dolls (not included).



IMPORTANT INFORMATION

- Keep dirt away from furniture with fabric and blankets.
- Snow foam beads are reusable. Collect snow and store in the bag to play again and again.
- Allow the ice on the skating rink to melt and pour out the water. Pour out the water from the pool when done playing. Air dry thoroughly before storing.
- Turn off items with batteries after every use to conserve battery power.
- Only the pool, skating rink and dolls are designed to be played with water. Keep water away from other contents.
- Overfilling the chimney chute with snow foam beads may cause it to stop running. If this occurs, turn it off for 5 minutes and then turn it back on.

Please keep this manual as it contains important information.



0719-1-E/INT
Printed In China

www.LOLsurprise.com
©2019 MGA Entertainment, Inc.
L.O.L. SURPRISE!™ is a trademark of MGA in the U.S. and other countries. All logos, names, characters, likenesses, images, slogans, and packaging appearance are the property of MGA.

MGA Entertainment, Inc.
9220 Winnetka Ave., Chatsworth, CA 91311
U.S.A.
(800) 222-4685

MGA Entertainment UK Ltd.
50 Presley Way, Crownhill, Milton Keynes,
MK8 0ES, Bucks, UK
+ 0800 521 558

MGA Entertainment (Netherlands) B.V.
Klipperaak 201, 2411 ND Bodegraven, NL
Tel.: +31 (0) 172-758 038
E-mail: klantenservice@mgae.com

Imported by MGA Entertainment Australia Pty Ltd
Suite 2.02, 32 Delhi Road
Macquarie Park NSW 2113
1300 059 676

The preferred method of contact for Customer Service is through our e-mail contact form at www.mgae.com



SKU: 562207 · AGES 3+ · ADULT ASSEMBLY REQUIRED



WATCH THE CHALET ASSEMBLY VIDEO:
LOLSURPRISE.COM



*ALL DOLLS NOT INCLUDED. SEE CONTENTS FOR INCLUDED ITEMS.

Illustrations are for reference only. Styles may vary from actual contents.

⚠ WARNING:

- ADULT ASSEMBLY REQUIRED.
- ADULT SUPERVISION IS REQUIRED when children are playing in or around water.
- Prior to assembly, this package contains small parts: screws which are a choking hazard and may contain sharp edges and sharp points. Keep away from children until assembled.
- Avoid placing the unit on an uneven surface or anywhere which might offer the possibility of tipping.
- Do not sit, stand, or jump on the unit, as doing so may result in bodily injury and/or damage to the unit.
- Not suitable for children under 3 years of age due to size limitations.
- Remove pull tabs from the toilet and fireplace before use.
- Do not use water with the toilet.
- Always empty water from the pool and ice rink and dry thoroughly before storing.
- Only apply stickers to the included house and accessories, as adhesive may not be completely removed from all surfaces.
- Snow foam beads are not food. DO NOT eat.
- Avoid inserting other objects into the chimney. Only use the snow foam beads included with this product.
- Do not place face directly in front of the chimney's vent when it is on.

CONTENTS

Before assembling, ensure you have all pieces.
Some furniture assembly may be required prior to assembling the unit.

A	B	C x 2	D	E	F
G	H	I	J	K	L
M	N	O	P	Q	R
S	T	(1) x 45	(2) x 2	(3)	
(4)	(5)	(6)	(7)	(8)	(9)
(10)	(11)	(12)	(13)		
(14)	(15)	(16)	(17)		
(18)	(19)	(20)	(21)	(22)	(23)

WALL MOUNTING ASSEMBLY

- For added safety and stability, install the wall mounting hardware.
- Always use wall anchors appropriate to your wall type, like plaster, drywall, concrete, etc.
- When possible, mount to wood studs.
- Consult a qualified professional for mounting.

HARDWARE

- A. Screw
- B. Small Washer x 2
- C. Plastic Strip
- D. Plastic Anchor
- E. Wood Screw
- F. Nut
- G. Large Washer
- H. Wrench

NOT INCLUDED



1 Attach the plastic strip to the back of the product. There is a pre-drilled hole on the house's backboard (O).

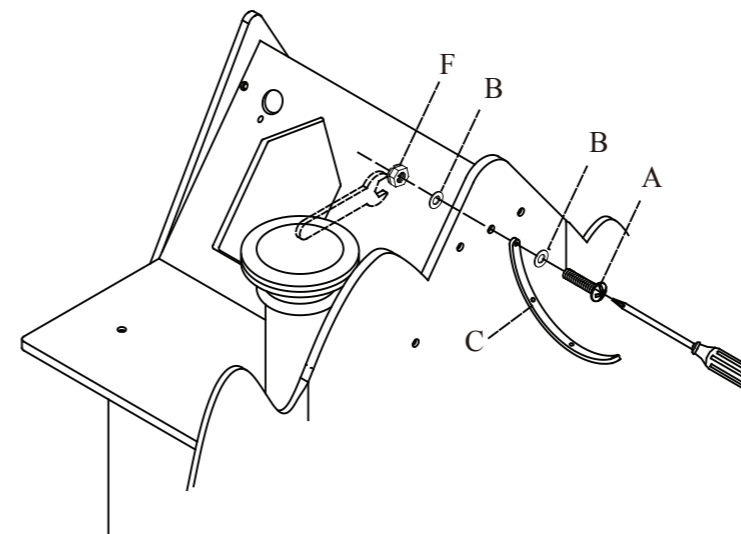

2 Use a 1/4" (6.5 mm) drill bit to drill a pilot hole in the wall. DO NOT drill an oversized hole, or the anchor will not hold tightly to the wall. Tap the wall anchor into the hole. Secure the house to the wall with a screw (E) through the plastic strip and into the wall anchor.

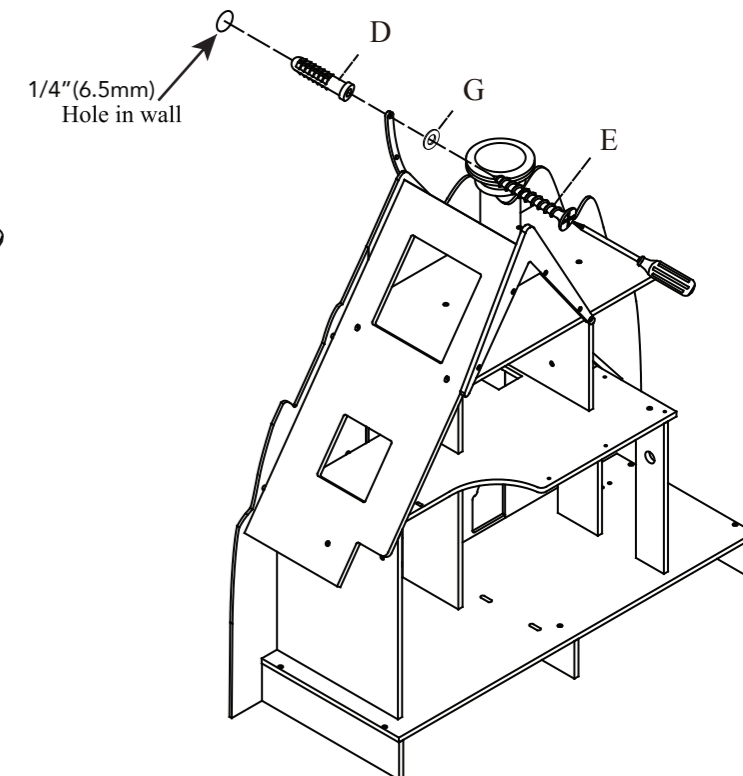

⚠ WARNING:

- DO NOT install on a wall where items can fall off and injure a child.
- CHOKING HAZARD: Unassembled parts may be a choking hazard to children 3 years and younger.
- Adult assembly required. Hardware contains small screws with sharp points. Keep unassembled parts out of reach of small children.
- Serious or fatal injuries can occur from furniture tipping over. To prevent the product from tipping:
 - Use mounting hardware to secure the house to a wall. This will reduce, but NOT eliminate, the risk of tipping over.
 - DO NOT allow children to climb on the house.
 - Keep remote controls, toys, and other items that might attract children away from this product.
 - DO NOT place heavy items, like televisions, on top of this product.

SAFE BATTERY USAGE

- Use alkaline batteries for best performance and longer life.
- Use only the battery type recommended for the unit.
- Batteries should be replaced only by an adult.
- Insert batteries with the correct polarity (+ and -).
- Do not mix old and new batteries.
- Do not mix alkaline, standard (carbon-zinc), or rechargeable batteries.
- Do not short-circuit batteries.
- When not used for an extended time, remove batteries to prevent possible leakage and damage to the unit.
- Do not mix rechargeable and non-rechargeable batteries.
- Rechargeable batteries are to be removed from the toy before charging.
- Rechargeable batteries are to be recharged only under adult supervision.
- Do not recharge non-rechargeable batteries.
- Exhausted batteries are to be removed from the toy.
- Do not dispose of batteries in fire as they may leak or explode.

FCC COMPLIANCE

NOTE: This equipment has been tested and found to comply with the limits for a Class B digital device, pursuant to Part 15 of the FCC Rules. These limits are designed to provide reasonable protection against harmful interference in a residential installation. This equipment generates, uses and can radiate radio frequency energy and, if not installed and used in accordance with the instructions, may cause harmful interference to radio communications. However, there is no guarantee that interference will not occur in a particular installation. If this equipment does cause harmful interference to radio or television reception, which can be determined by turning the equipment off and on, the user is encouraged to try to correct the interference by one or more of the following measures:

- Reorient or relocate the receiving antenna.
- Increase the separation between the equipment and receiver.
- Connect the equipment into an outlet on a circuit different from that to which the receiver is connected.
- Consult the dealer or an experienced radio/TV technician for help.

This device complies with Part 15 of the FCC Rules. Operation is subject to the following two conditions: (1) This device may not cause harmful interference, and (2) this device must accept any interference received, including interference that may cause undesired operation.

Caution: Modifications not authorized by the manufacturer may void users authority to operate this device. CAN ICES-3 (B)/NMB-3(B).

! WARNING:

This product contains a Button or Coin Cell Battery. A swallowed Button or Coin Cell Battery can cause internal chemical burns in as little as two hours and lead to death. Dispose of used batteries immediately. Keep new and used batteries away from children. If you think batteries might have been swallowed or placed inside any part of the body, seek immediate medical attention.



'Let's care for the environment!'

The wheelie bin symbol indicates that the product must not be disposed of with other household waste. Please use designated collection points or recycling facilities when disposing of the item.

Do not treat old batteries as household waste. Take them to a designated recycling facility.

CONTENTS

(24)	(25)	(26)	(27)	(28)	(29)
(30)	(31)	(32)		(33) x 4	(34)
(35)	(36) x 2	(37)	(38)	(39)	(40) x 32
(41)	(42)	(43)	(44)	(45)	(46)
(47)	(48)	(49)	(50)	(51)	(52)
(53)	* (57)				

* Boy characters are anatomically correct.

FURNITURE ASSEMBLY

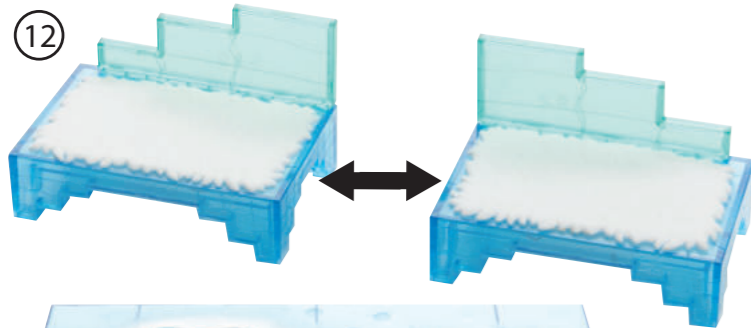
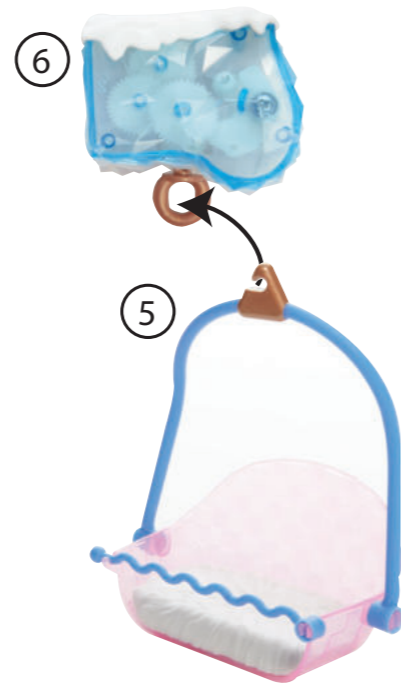

BATTERY INSTALLATION AND REPLACEMENT INFORMATION

*NOT INCLUDED: (10) (20) (T)

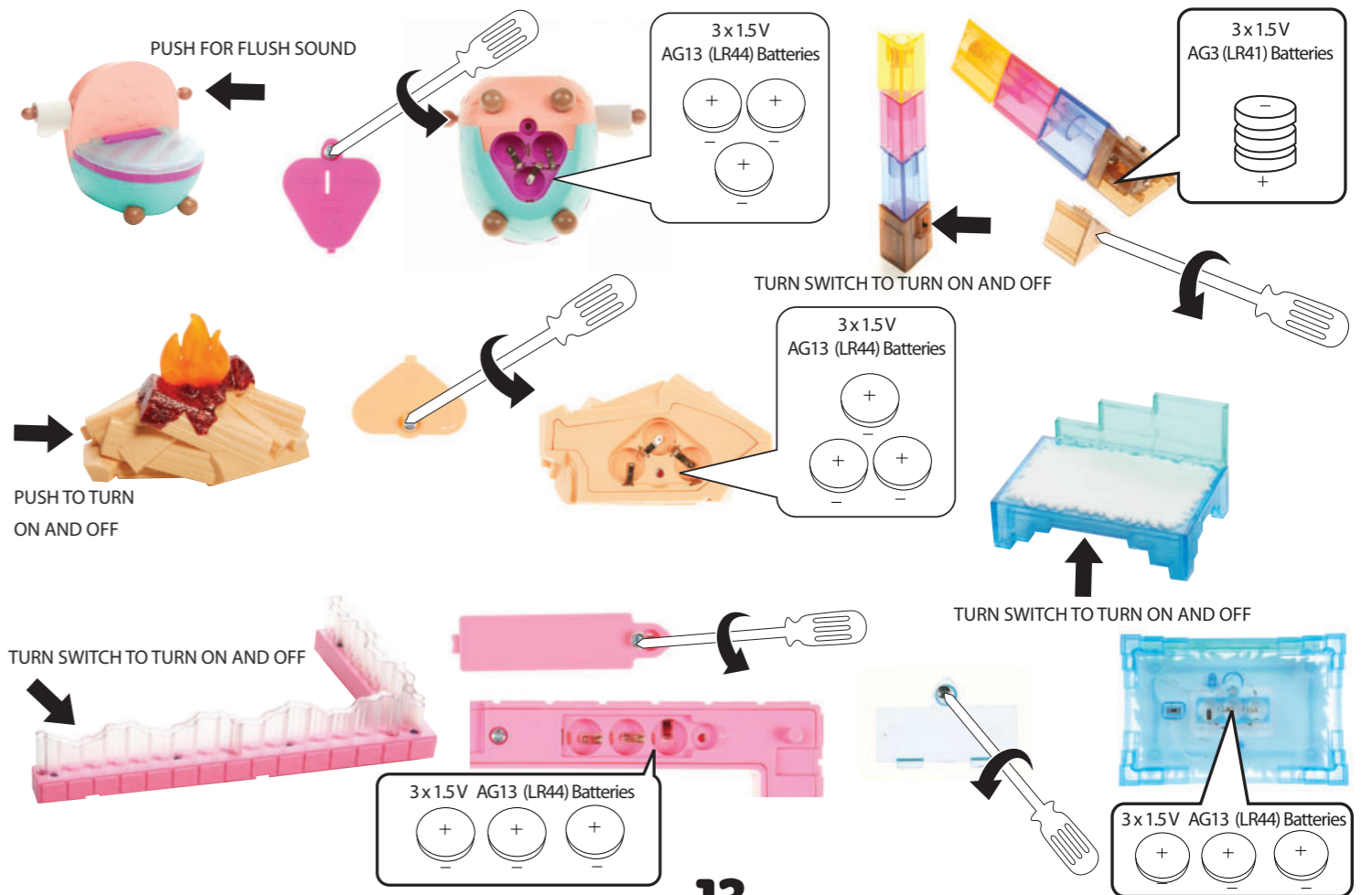
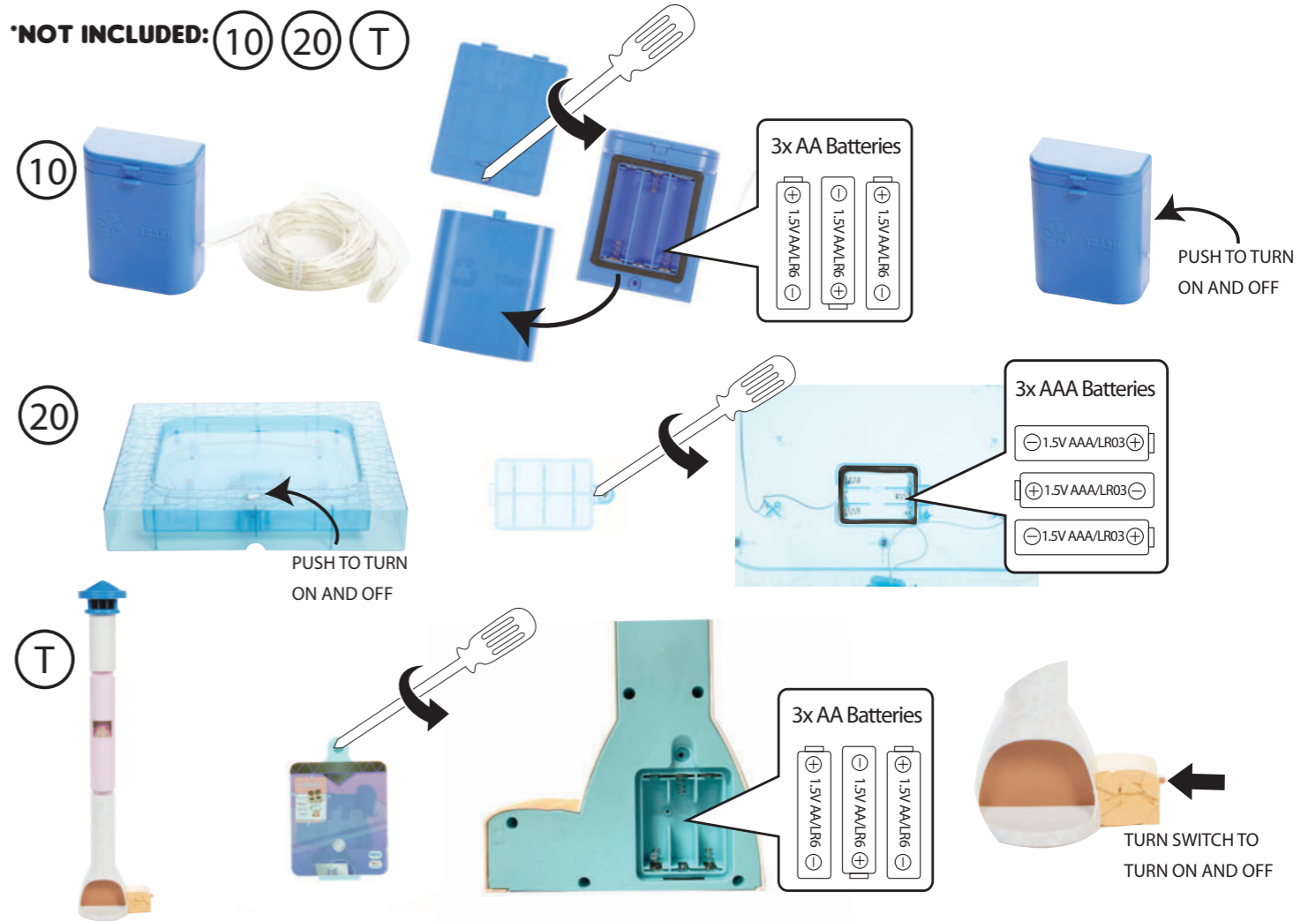

LET'S PLAY!



COLOR CHANGE INFORMATION

- Cold color change will start at approximately 59°F (15°C), but best results occur if the ice water is chilled to approximately 32°F (0°C) or colder.
- Warm water color change will start at approximately 100.4°F (38°C), but best results occur if the water is approximately 104°F (40°C).
- Do not place the character in extremely hot water (over 109.4°F/43°C).
- Color change will only work on certain parts of the character's body or accessories. Not all included accessories change color.
- If color change does not work properly or quickly, the temperature of the character's body may be too close to the temperature of the water.
- Color change temperatures may vary according to weather conditions.
- The color-change effect has a lengthy, but limited lifespan.
- Do not store the character in direct sunlight for extended periods of time.
- Exposure to sunlight may deactivate color change feature.

* ⚠ WARNING

An adult must be present and supervise when placing the character in warm water, as the water may be hot.

IMPORTANT INFORMATION

- Before beginning, cover the play area to protect from possible water damage.
- Fill the bottle and feed the pet two times.
- Squeeze out all water from the bottle and pet after each use.
- An adult must be present when children are playing with water.
- Thoroughly dry the characters, parts and accessories in a well-ventilated area after use and before storing.
- Immediately wipe up spilled water after playing. To prevent spillage, carefully lift the pool out of the base and empty the water. Air dry thoroughly before next use.
- Air dry only. Do not place in the dryer or subject to excessive heat.
- Boy characters are anatomically correct.

AFTER ASSEMBLY

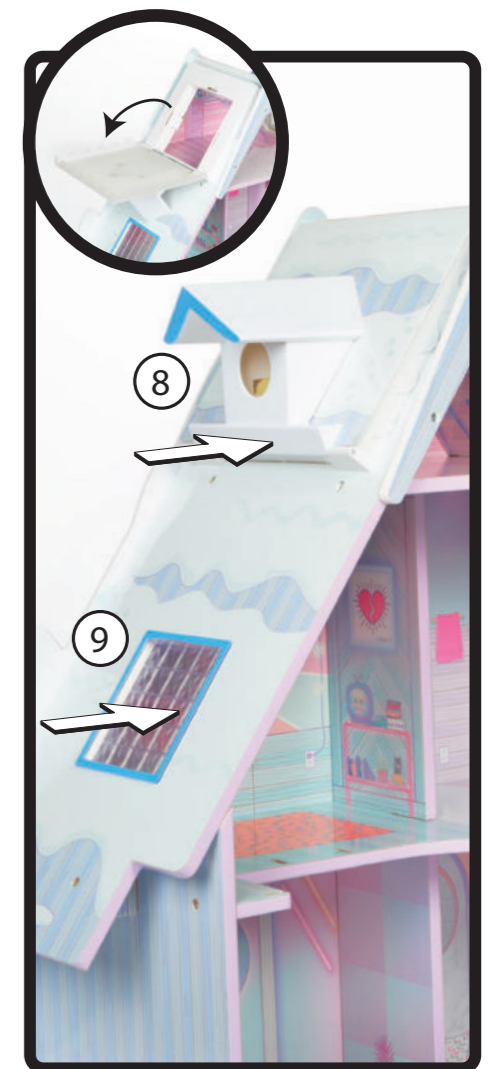
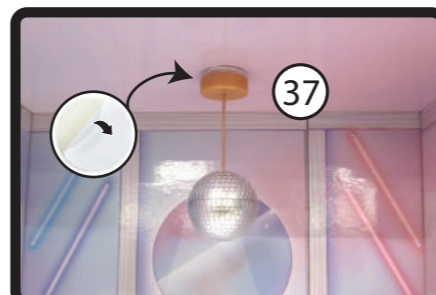
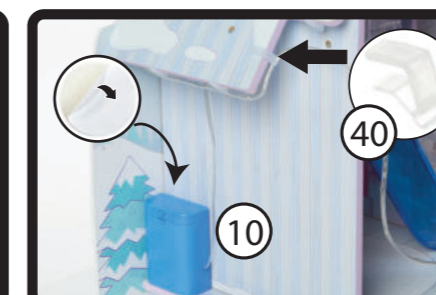
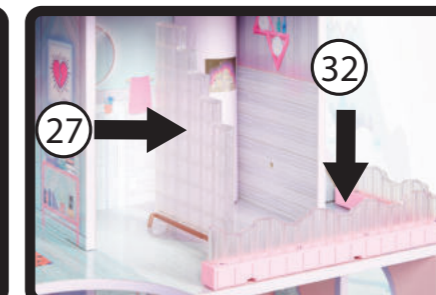
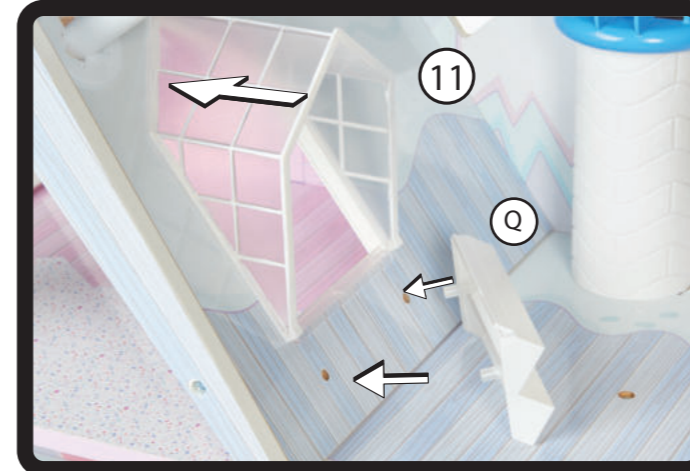
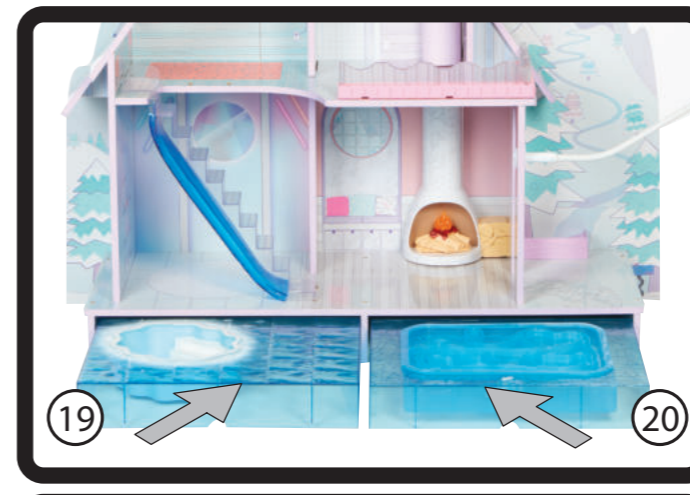

ADULT ASSEMBLY REQUIRED

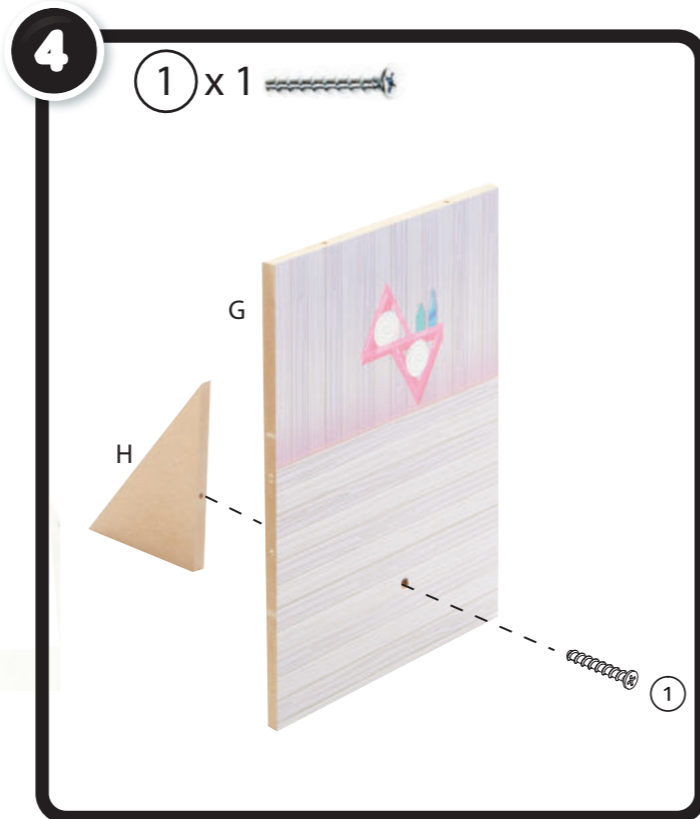
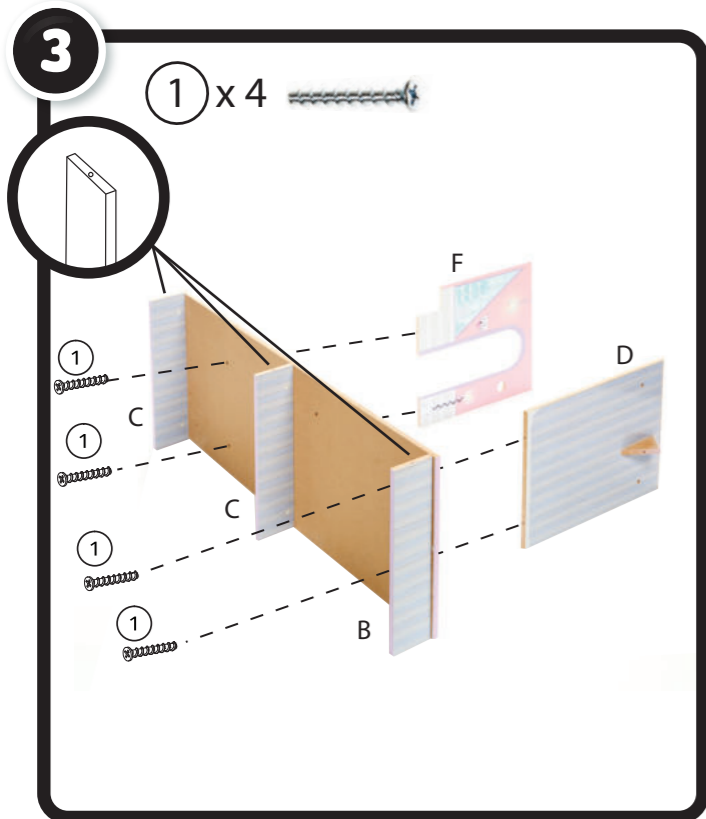
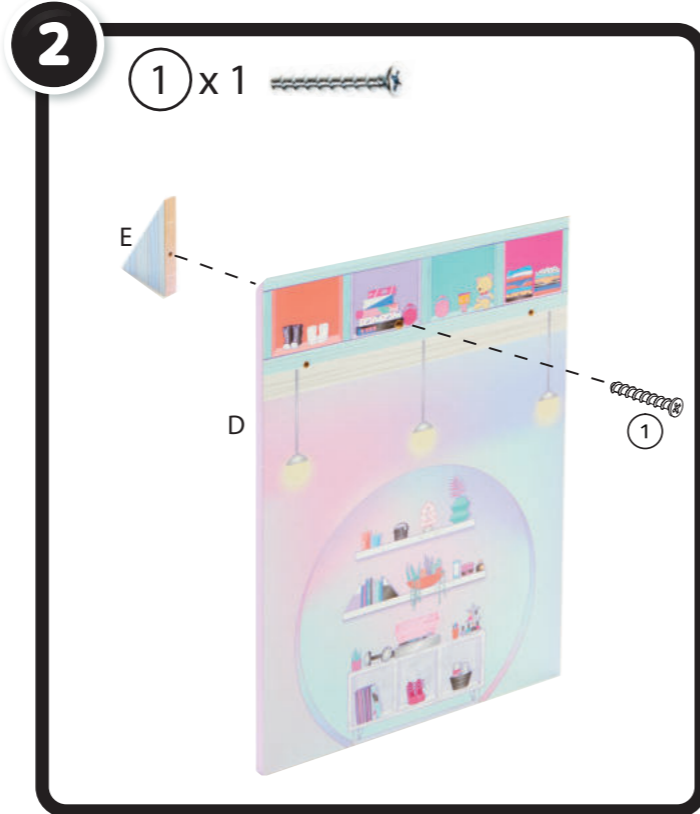
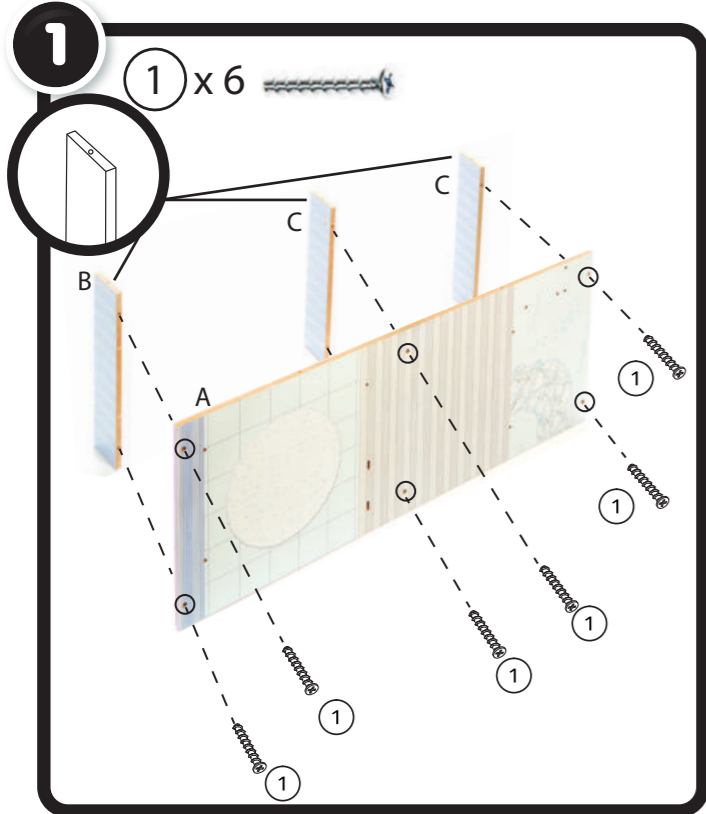
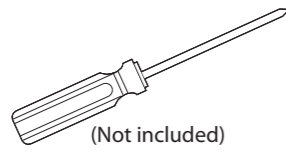

SKI LIFT RAILING IS A ONE-TIME SNAP.

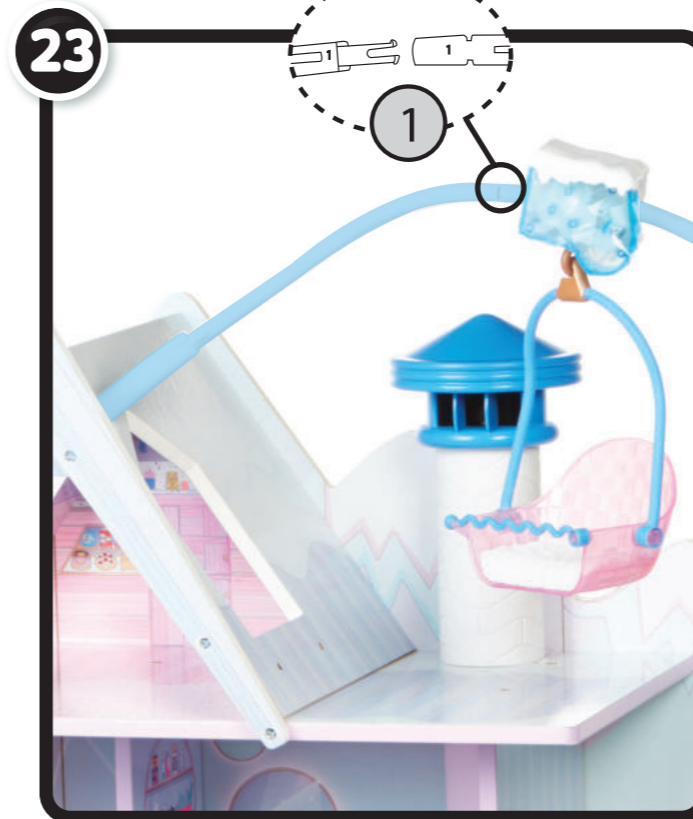
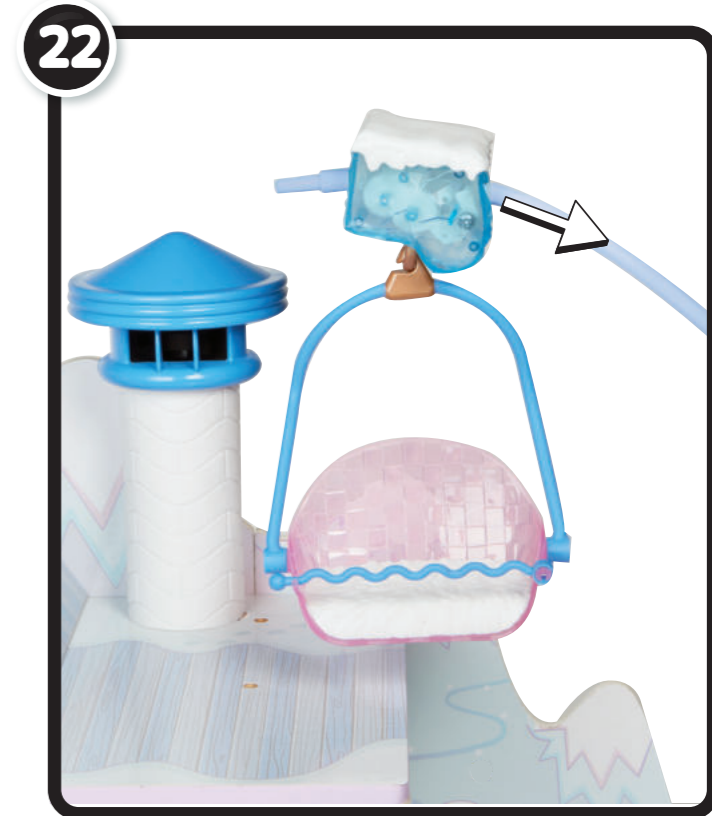
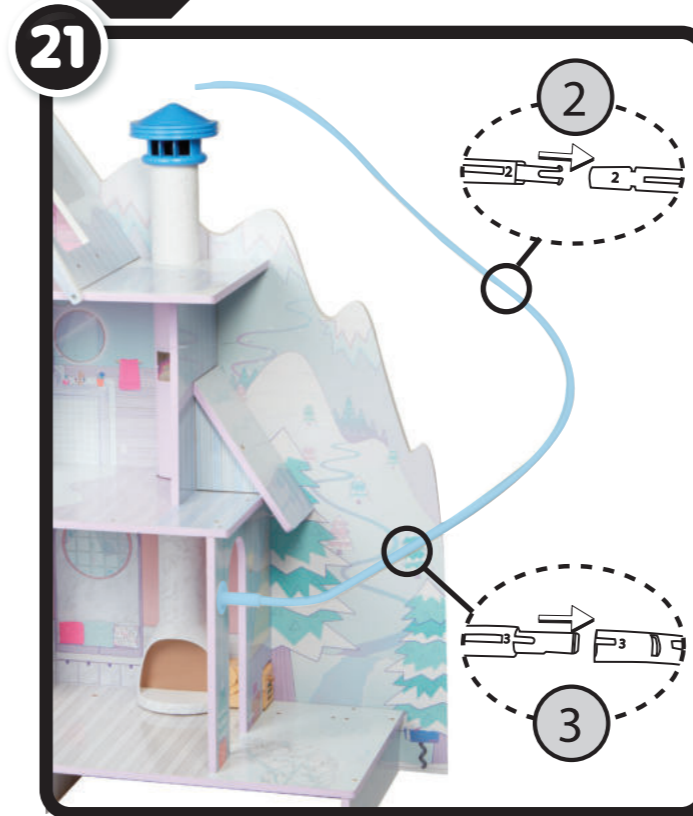

INSERT DOLL IN SKI LIFT AND PUSH TO ACTIVATE SKI LIFT.

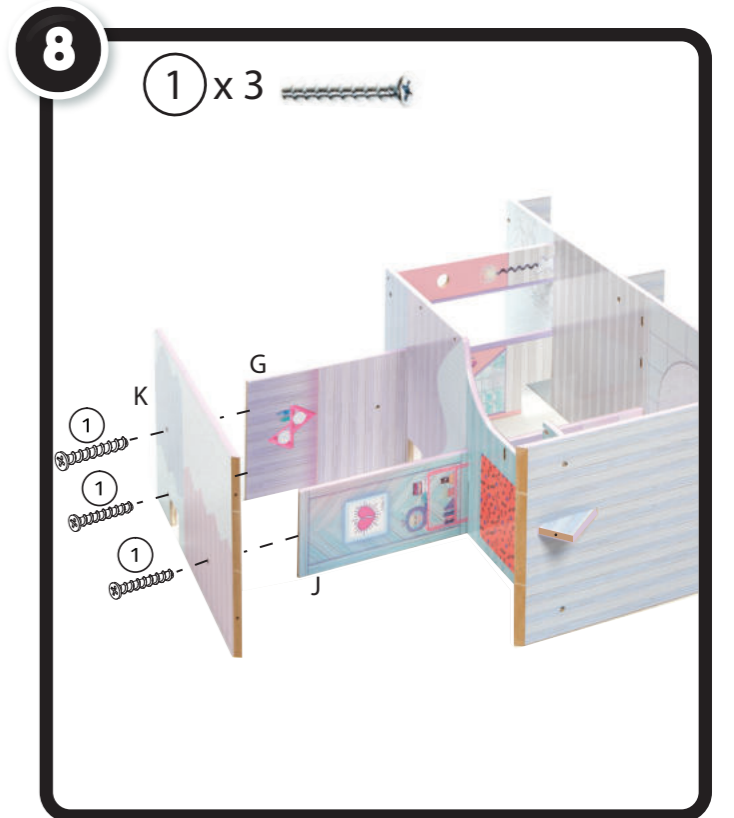
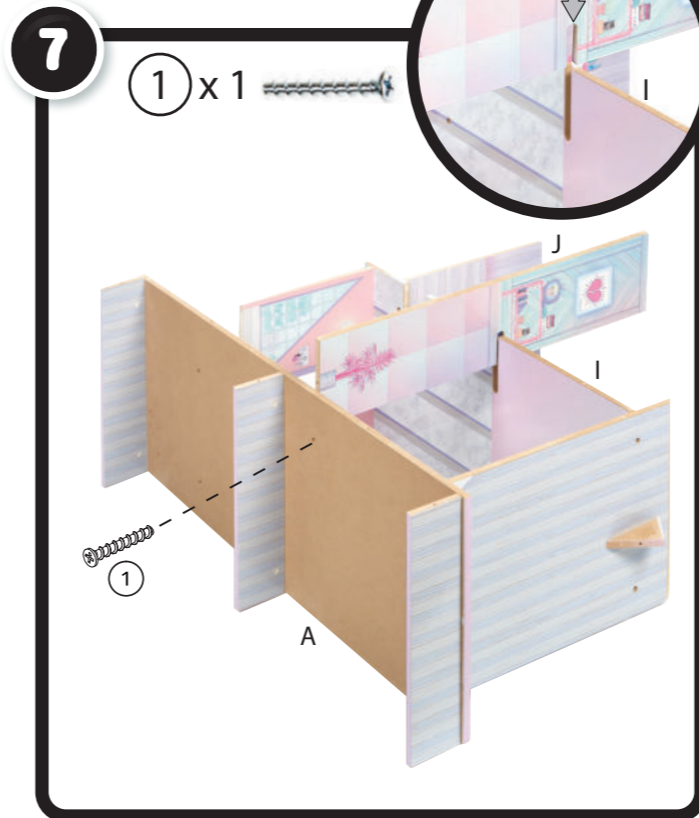
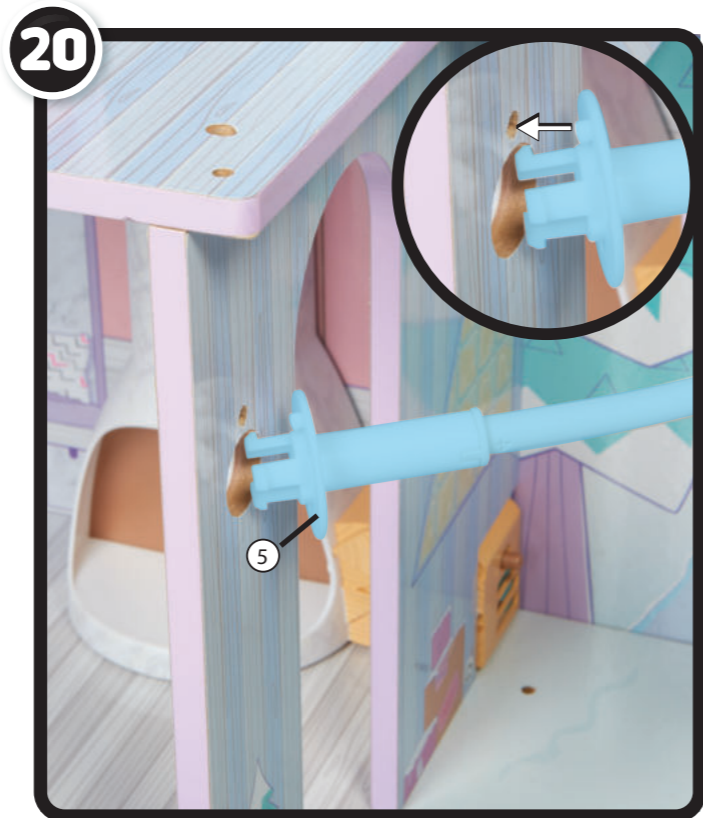
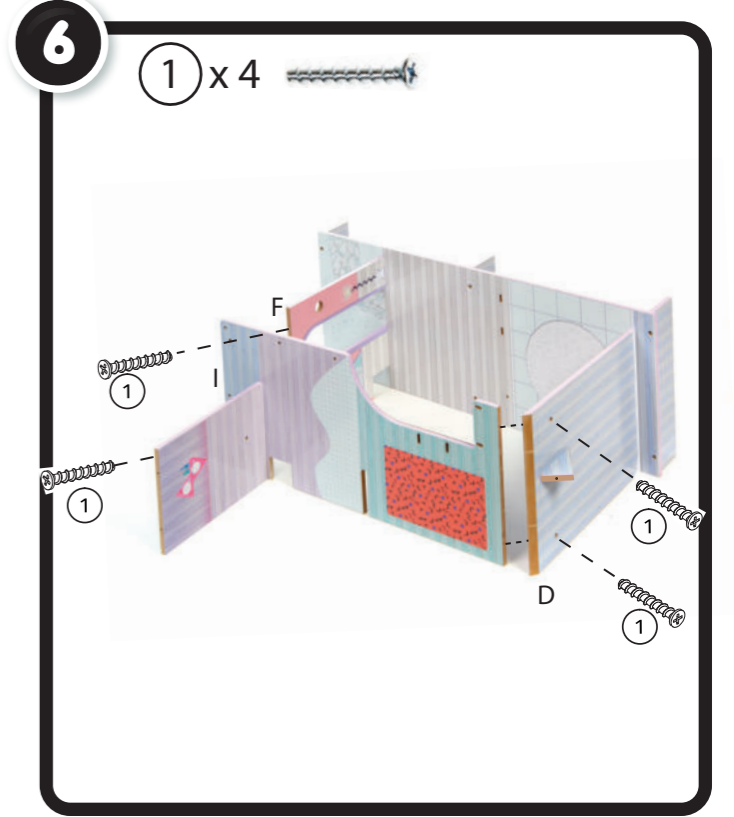
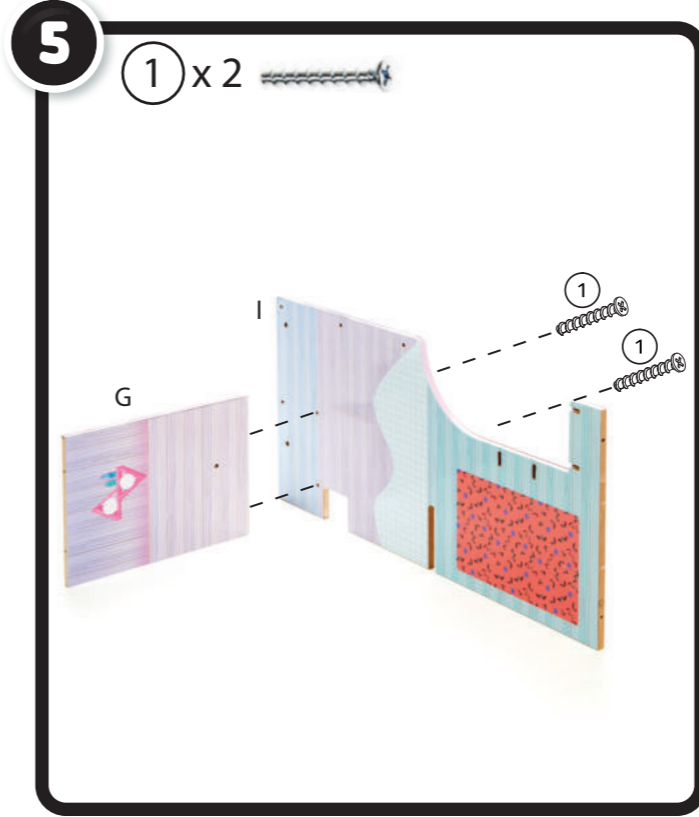
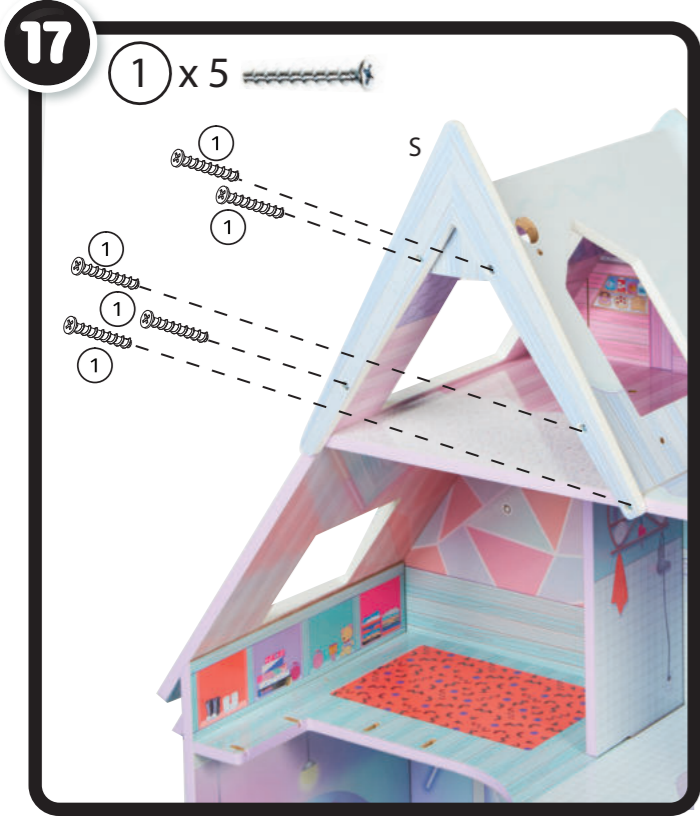

*FLIP OVER TO ADD J.

