

USING NAIL POLISH

1. After you have applied your new nails, place each finger on the finger placements on the top of your counter playset for stability and begin designing; see below:

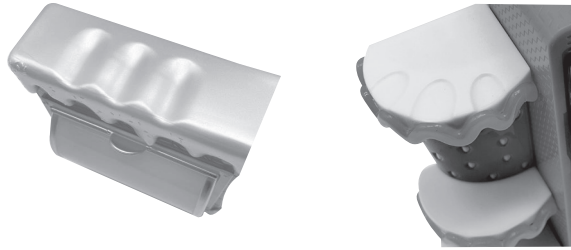

2. Unscrew the cap on the nail polish.
3. Apply a thin coat of nail polish to the nails.
4. Allow the coat to dry; dry time is about 15-30 minutes. Add coats as desired.
5. Then, add stickers to your nails to customize once the nail polish has dried; see below for glitter design instructions!

GLITTER DESIGN

1. Apply a thin coat of nail polish to your plastic nail. **TIP:** Do a glitter design on one nail at a time.
2. With the nail polish still wet, dip your nail into the powder.
3. Allow your glitter design to dry completely. Repeat these steps on the nails that you want to have a glitter design.



Create unique designs:

1. Whole nail with glitter
2. Heart symbol with glitter
3. Glitter stripes
4. Half of the nail with glitter
So many more!



Please keep this manual as it contains important information.

www.LOLsurprise.com
©2023 MGA Entertainment, Inc.
L.O.L. SURPRISE!™ and L.O.L. SURPRISE! O.M.G.™ are trademarks of MGA in the U.S. and other countries.
All logos, names, characters, likenesses, images, slogans, and packaging appearance are the property of MGA.

The preferred method of contact for Customer Service is through our e-mail contact form at www.mgae.com

MGA Entertainment, Inc.
9220 Winnetka Ave. Chatsworth, CA 91311 U.S.A.
(800) 222-4685

MGA Entertainment UK Ltd.
50 Presley Way, Crownhill, Milton Keynes,
MK8 0ES, Bucks, UK
+ 0800 521 558

MGA Entertainment (Netherlands) B.V.
Baronie 68-70, 2404 XG Alphen a/d Rijn, The Netherlands
Tel: +31 (0) 172 758038

Imported by MGA Entertainment Australia Pty Ltd
Suite 5.05, 32 Delhi Road
Macquarie Park NSW 2113
1300 059 676



SKU: 503781, 503842, 503859

SWEET NAILS

WARNING:
CHOKING HAZARD-Small parts.
Not for children under 3 years.

AGES 4+
ADULT SUPERVISION REQUIRED

CONTENTS

- | | | | | | | | | | |
|----|---|----|-----------------------|----|-----------------------|----|-----------------------|----|-----------------------|
| A. | 1 Fashion Doll
- 3 Fashions
- 1 Pair of Earrings
- 1 Pair of Shoes | B. | 1 Main Unit | C. | 2 Nail Polish Bottles | D. | 24 Molded Color Nails | E. | 1 Nail Glitter Packet |
| F. | 1 Glitter Jar | G. | 24 pcs Nail Adhesives | H. | 1 Nail File | I. | 3 Nail Sticker Sheets | | |

EACH SOLD SEPERATELY

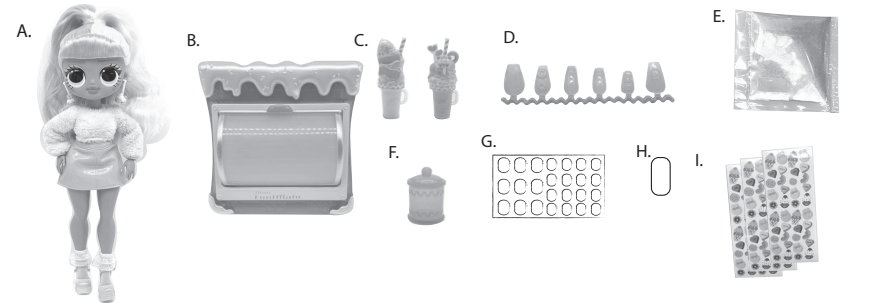

EACH SOLD SEPERATELY

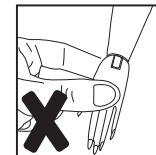
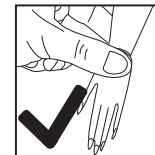
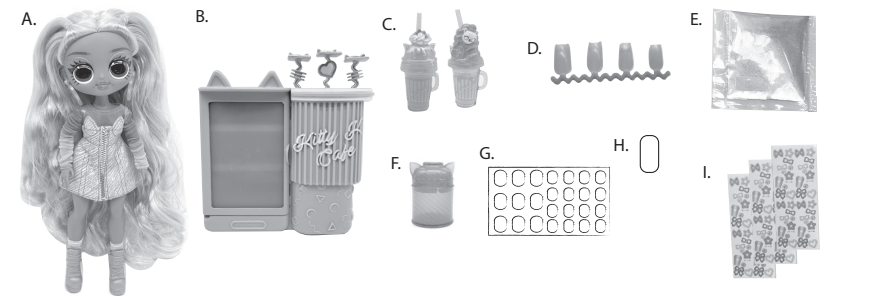

TIPS:

- When removing the hands to dress doll, pinch the wrists' joints and gently pull. **DO NOT PULL FROM THE FINGERS.**
- Your doll is articulated, but the knee joint will need to be loosened. To loosen the knee joint, use slight force to pull the leg forward until the knee clicks. Then, push the leg back and it will click again.

Illustrations are for reference only. Styles may vary from actual contents.

⚠ WARNING:

- For use under adult supervision. Keep out of reach of very young children.
- Keep away from eyes. In case of direct contact with eyes, rinse immediately with plenty of water and seek medical advise.
- Cosmetics are for external use only. Do not eat, drink or inhale any cosmetics or contents included in this product.
- Do not use cosmetics on broken skin.
- As with all cosmetics, some individuals skin types may experiene minor skin irritation. If this occurs, discontinue use.
- Do not apply product to furniture, pet, etc.
- Wash hand before and after using cosmetics.

IMPORTANT INFORMATION AND CARE INSTRUCTIONS

- Nail polish and glitter can be applied to both real finger nails and plastic nails.
- Do not blow the glitter at people, pets or their eyes.
- To prevent nail polish from drying out, always close the cap after each use.
- Only apply adhesives and stickers to your nails, as they may not be removed from all surfaces.
- Color transfer from pigments may occur. Wash hands thoroughly after use and keep cosmetics away from clothing and surfaces other than provided containers.
- Products may damage or stain certain fabrics, carpeting, wood finishes, or other porous and polished surfaces. Protect and cover surrounding surfaces before using cosmetics.
- Rinse the glitter jar in water and allow to air dry thoroughly before storing.
- Do not leave cosmetics in the sun or in very hot areas.
- Do not wash the doll's hair with water and/or soap.
- Do not dry doll's hair with a hair dryer or subject hair to very high heat in any manner, as it will irreparably damage the hair.
- Do not store the doll in direct sunlight for extended periods of time.
- Illustrations are for reference only. Styles may vary from actual content.
- Use only as directed in these instructions.
- Please keep this manual as it contains important information.

KEYLOCK

1. To unlock, turn the keylock located on the back of the counter playset clockwise.
2. Pull the keylock out and discard in a recyclable bin.
3. The counter playset can now be easily removed.

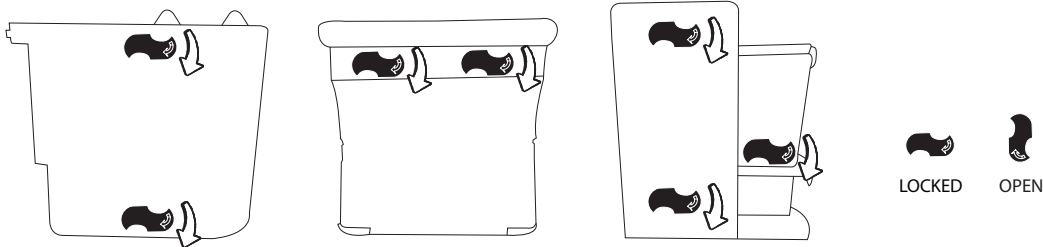

GETTING STARTED

Before beginning, cover the play area to protect from possible damage.

Glitter Jar:

1. With adult supervision, use child-safe scissors to cut open the packet of glitter found inside the glitter jar. Cut along the guidelines indicated on the packet.
2. Open the glitter jar and pour the glitter inside.
3. Close the jar until you are ready for glitter application.



Display:

1. Place nail polishes or glitter jar on top of the counter playset.
2. Open the door on the counter playset to display and store nail sets; find your playset below to see how.
3. Slide the shelves out (Note: Candylicious does not have pullout shelves) and place each nail set within the groove until you are ready for nail application.



NAIL APPLICATION

1. Select the nail set design you want to use. **TIP:** Be sure the plastic nail matches the correct size of your real nail.
2. Twist the nails to break them off from the nail holder.
3. Use the nail file to file the edge where the nail detached from the holder until it is smooth.



4. Choose the correct size adhesive for each plastic nail.
5. Peel off a nail adhesive and place it to your real finger nail.
6. Then, peel off the top layer of the nail adhesive and discard.
7. Place the plastic nail over the adhesive and press down to secure it to your real nail. Repeat for all nails.

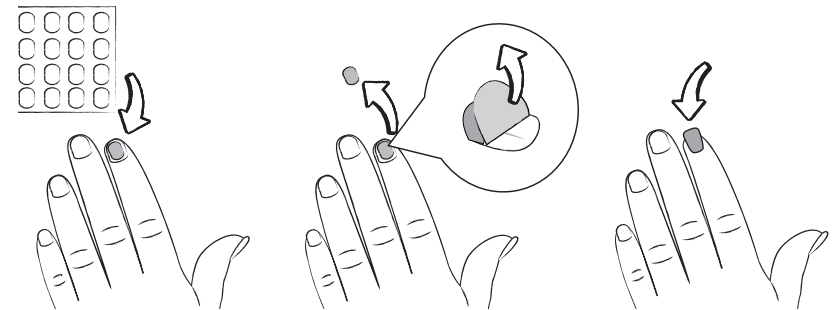

To remove the plastic nails, simply peel off each plastic nail from your real nail; nail polish remover is not needed. The nail adhesive should come off with the plastic nail. If the nail adhesive remains on your real finger nail simply peel or roll off the remaining adhesive or use warm water if needed. **Note:** Nail adhesives are not reusable.